

UMS 7-90CC RADIAL ENGINE SPECIFICATION

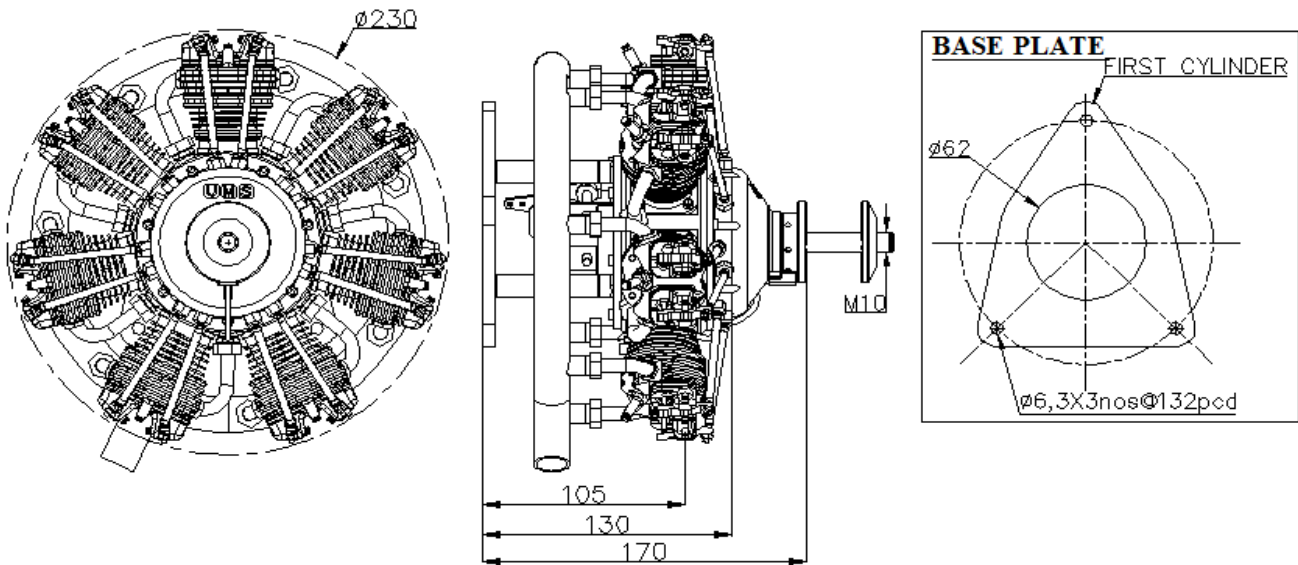

7-90CC SPECIFICATION

TYPE	SPARK IGNITION
CYLINDER	7 (ABC TYPE)
CAPACITY	90CC
BORE	25.1MM
STROKE	26MM
THRUST (Approx.)	9.5kgf @ 24X10 MENZ PROP.
RPM RANGE	1000-6000
WEIGHT	2.8kg incl.(silencer)
ENGINE DIAMETER	230MM
ENGINE LENGTH	170MM
PROPELLER (MENZ TWO BLADE WOOD)	24X8,24X10,24X12
MUFFLER TYPE	COLLECTOR RING
PLUG TYPE	1/4-32 RcExl
CARBURETOR	WALBRO WT-621